

Disconnectors for
Photovoltaic Applications

TABLE OF CONTENTS

Switching program: 1 x 2-pole			
Operating voltage U_e	Utilization category	Rated operational current I_e	Page
DIN rail mounting			
450 V DC	DC-PV2	18 A / 25 A / 32 A	4
500 V DC	DC-PV2	12 A / 18 A	4
500 V DC	DC-PV2	25 A	5
650 V DC	DC-PV2	18 A / 25 A / 32 A	5
800 V DC	DC-PV2	12 A / 20 A	5
800 V DC	DC-PV2	18 A / 25 A / 32 A	6
650 V DC	DC-PV0	60 A	7
800 V DC	DC-PV0	60 A	8
In enclosure			
450 V DC	DC-PV2	18 A / 25 A / 32 A	9
500 V DC	DC-PV2	12 A / 18 A / 20 A	9
500 V DC	DC-PV2	25 A	10
650 V DC	DC-PV2	18 A / 25 A / 32 A	10
800 V DC	DC-PV2	12 A / 20 A	10
800 V DC	DC-PV2	18 A / 25 A / 32 A	11
600 V DC	DC-PV0	60 A	12
800 V DC	DC-PV0	60 A	12

Switching program: 1 x 2-pole, 2 x 2-pole and 3 x 2-pole			
Operating voltage U_e	Utilization category	Rated operational current I_e	Page
Fronteinbau			
500 V	DC-PV2	20 A	13
750 V	DC-PV2	20 A	14
1000 V	DC-PV2	20 A	15

UL-approved switches upon request.

Abbreviations for tables	
U_e	Operating voltage
I_e	Rated operational current
Max. U_i PV	Max. open-circuit voltage of PV generators $U_{OC,STC}$
U_i	Insulation voltage

450 V DC : 18 A / 25 A / 32 A
500 V DC : 12 A / 18 A

1 x 2-pole

Switching program: 2-pole, 4 contacts per circuit (2 x 2 in series)

DC-side disconnectors for photovoltaic power supply systems in accordance with IEC 60364-712:2002

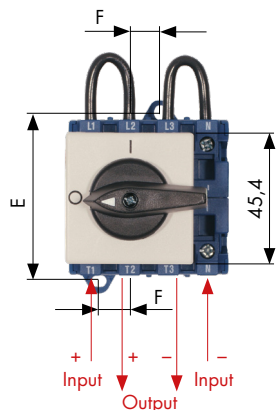
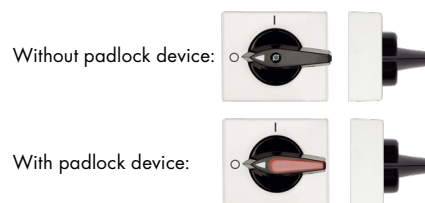
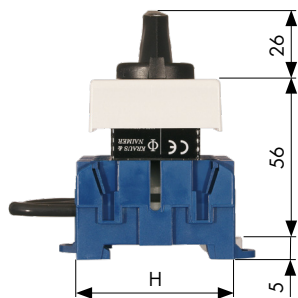
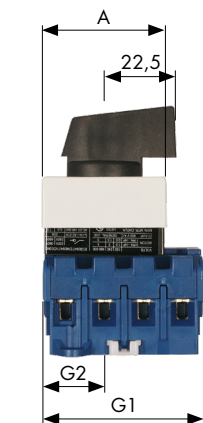

	KG20A/ KG32A	KG41
A	43,7	52,4
E	60	70
F	11	12,5
G1	55,5	66
G2	21	25
H	54	64

Wiring diagram	Twist torque for clamping screws	Stripped length
	1,25 Nm	
	1,80 Nm	

General Data

Switch disconnectors in accordance with EN 60947-3, VDE 0660 part 107

Utilization category for photovoltaic applications: **DC-PV2** Connecting and disconnecting a PV circuit, where severe overcurrent may occur and where the current can flow in both directions

DC-21B Switching of resistive loads, including moderate overloads

Ambient temperature (open): 50 °C over 24 hours with peaks of up to 55 °C

Finger-safe terminals in accordance with VDE 0660-514 and BGV A3, protection class IP 20

Maximum conductor cross section (use only copper conductors)

single wire or stranded wire	KG20A/KG32A: 6 mm ²	KG41: 16 mm ²
flexible wire without / with wire-end ferrules (according to DIN 46228)	KG20A/KG32A: 4 mm ²	KG41: 10 mm ²

Mounting

DIN rail mounting with screw and quick mounting in accordance with EN 60715

Faceplate for 45 mm standard cutout, F-handle grey, with interlock

Name without padlock device	Art. No.	Name with padlock device	Art. No.	U _e	I _e DC-PV2	I _e DC-21B	Max. U _L PV	U _i *
KG20A.T304/P1.VE2	70040660	KG20A.T104/P5.VE2	70046559	450 V DC	18 A	25 A	540 V DC	690 V
KG32A.T304/P1.VE2	70040661	KG32A.T104/P5.VE2	70046560	450 V DC	25 A	25 A	540 V DC	690 V
KG41.T304/P1.VE2	70040662	KG41.T104/P5.VE2	70046561	450 V DC	32 A	40 A	540 V DC	690 V
KG20A.T304/P1.VE2	70040660	KG20A.T104/P5.VE2	70046559	500 V DC	12 A	21 A	600 V DC	690 V
KG32A.T304/P1.VE2	70040661	KG32A.T104/P5.VE2	70046560	500 V DC	18 A	21 A	600 V DC	690 V
KG41.T304/P1.VE2	70040662	KG41.T104/P5.VE2	70046561	450 V DC	32 A	40 A	600 V DC	690 V

Data valid only if the pre-assembled bridges have not been modified.
 * Valid for ungrounded / midpoint-grounded PV grids, overvoltage category III, pollution degree III

500 V DC : 25 A
650 V DC : 18 A / 25 A / 32 A
800 V DC : 12 A / 20 A

1 x 2-pole

Switching program: 2-pole, 6 contacts per circuit (2 x 3 in series)

DC-side disconnectors for photovoltaic power supply systems in accordance with IEC 60364-712:2002

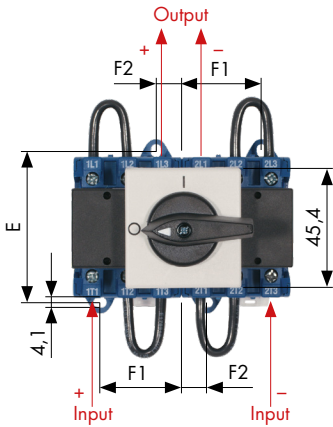
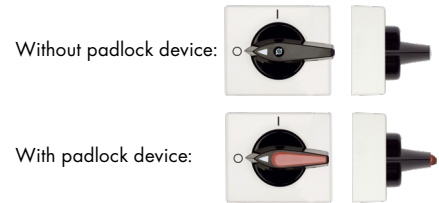
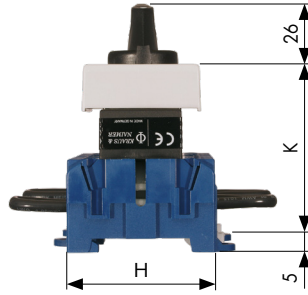

	KG20A / KG32A	KG41B
A	43,7	105,4
E	60	70
F1	32	37,5
F2	10	12,5
G	84	100
H	54	64
K	64	62,5

Wiring diagram	Twist torque for clamping screws	Stripped length
	1,25 Nm	KG20A / KG32A 9
	1,80 Nm	KG41B 10

General Data

Switch disconnectors in accordance with EN 60947-3, VDE 0660 part 107

Utilization category for photovoltaic applications: **DC-PV2** Connecting and disconnecting a PV circuit, where severe overcurrent may occur and where the current can flow in both directions

DC-21B Switching of resistive loads, including moderate overloads

Ambient temperature (open): 50 °C over 24 hours with peaks of up to 55 °C

Finger-safe terminals in accordance with VDE 0660-514 and BGV A3, protection class IP 20

Maximum conductor cross section (use only copper conductors)

single wire or stranded wire

KG20A / KG32A: 6 mm² KG41B: 16 mm²

flexible wire without / with wire-end ferrules (according to DIN 46228)

KG20A / KG32A: 4 mm² KG41B: 10 mm²

Mounting

DIN rail mounting with screw and quick mounting in accordance with EN 60715

Faceplate for 45 mm standard cutout, F-handle grey, with interlock

Name without padlock device	Art. No.	Name with padlock device	Art. No.	U _e	I _e DC-PV2	I _e DC-21B	Max. U _l PV	U _i *
<i>KG20A.T306/P1.VE2</i>	70040663	<i>KG20A.T106/P5.VE2</i>	70046562	650 V DC	18 A	25 A	780 V DC	1000 V
<i>KG32A.T306/P1.VE2</i>	70040664	<i>KG32A.T106/P5.VE2</i>	70046563	500 V DC	25 A	25 A	600 V DC	1000 V
<i>KG41B.T306/P1.VE2</i>	70040665	<i>KG41B.T106/P5.VE2</i>	70048006	650 V DC	32 A	40 A	780 V DC	1000 V
<i>KG20A.T306/P1.VE2</i>	70040663	<i>KG20A.T106/P5.VE2</i>	70046562	800 V DC	12 A	21 A	1000 V DC	1000 V
<i>KG32A.T306/P1.VE2</i>	70040664	<i>KG32A.T106/P5.VE2</i>	70046563	650 V DC	25 A	25 A	780 V DC	1000 V
<i>KG41B.T306/P1.VE2</i>	70040665	<i>KG41B.T106/P5.VE2</i>	70048006	800 V DC	20 A	28 A	1000 V DC	1000 V

Data valid only if the pre-assembled bridges have not been modified.

* Valid for ungrounded or midpoint-grounded PV grids, overvoltage category III, pollution degree III

800 V DC : 18 A / 25 A / 32 A

1 x 2-pole

Switching program: 2-pole, 8 contacts per circuit (2 x 4 in series)

DC-side disconnectors for photovoltaic power supply systems in accordance with IEC 60364-712:2002

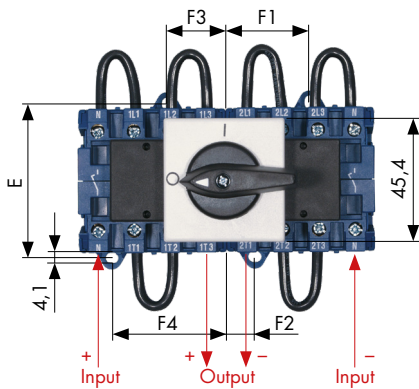
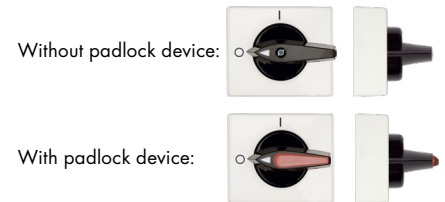
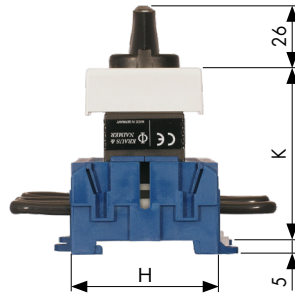
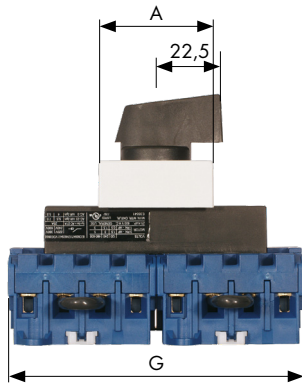

	KG20A KG32A	KG41B
A	43,7	105,4
E	60	70
F1	32	37,5
F2	10	12,5
F3	23,5	28,5
F4	45,5	53,5
G	111	132
H	54	64
K	64	62,5

Wiring diagram	Twist torque for clamping screws	Stripped length
	1,25 Nm	KG20A/ KG32A 9
	1,80 Nm	KG41B 10

General Data

Switch disconnectors in accordance with EN 60947-3, VDE 0660 part 107

Utilization category for photovoltaic applications: **DC-PV2** Connecting and disconnecting a PV circuit, where severe overcurrent may occur and where the current can flow in both directions

DC-21B Switching of resistive loads, including moderate overloads

Ambient temperature (open): 50 °C over 24 hours with peaks of up to 55 °C

Finger-safe terminals in accordance with VDE 0660-514 and BGV A3, protection class IP 20

Maximum conductor cross section (use only copper conductors)

single wire or stranded wire	KG20A/KG32A: 6 mm ²	KG41: 16 mm ²
flexible wire without / with wire-end ferrules (according to DIN 46228)	KG20A/KG32A: 4 mm ²	KG41: 10 mm ²

Mounting

DIN rail mounting with screw and quick mounting in accordance with EN 60715

Faceplate for 45 mm standard cutout, F-handle grey, with interlock

Name without padlock device	Art. No.	Name with padlock device	Art. No.	U _e	I _e DC-PV2	I _e DC-21B	Max. U _l PV	U _i *
KG20A.T308/P1.VE2	70040666	KG20A.T108/P5.VE2	70046565	800 V DC	18 A	25 A	1000 V DC	1000 V
KG32A.T308/P1.VE2	70040667	KG32A.T108/P5.VE2	70046566	800 V DC	25 A	25 A	1000 V DC	1000 V
KG41B.T308/P1.VE2	70040668	KG41B.T108/P5.VE2	70048007	800 V DC	32 A	40 A	1000 V DC	1000 V

Data valid only if the pre-assembled bridges have not been modified.
* Valid for ungrounded or midpoint-grounded PV grids, overvoltage category III, pollution degree III

Switching program: 2-pole, 6 contacts per circuit (2 x 3 in series)

DC-side disconnectors for photovoltaic power supply systems in accordance with IEC 60364-712:2002

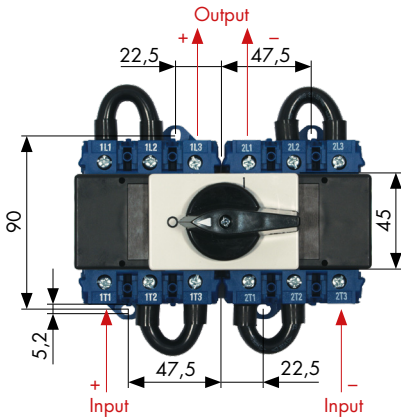
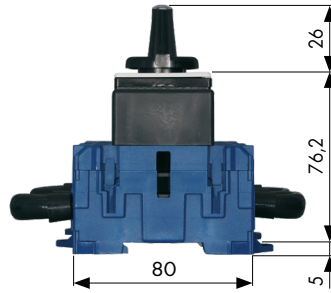
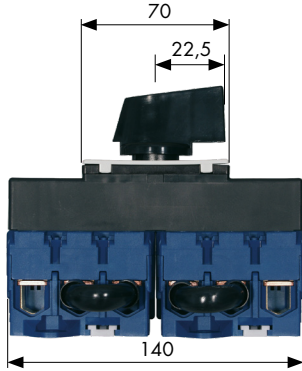

Wiring diagram	Twist torque for clamping screws	Stripped length
	KG80 3,00 Nm	KG80 14

General Data

Switch disconnectors in accordance with EN 60947-3, VDE 0660 part 107

Utilization category for photovoltaic applications: **DC-PV0** Opening and closing a PV circuit to disconnect when no current is flowing
DC-21B Switching of resistive loads, including moderate overloads

Ambient temperature (open): 50 °C over 24 hours with peaks of up to 55 °C

Finger-safe terminals in accordance with VDE 0660-514 and BGV A3

Maximum conductor cross section (use only copper conductors)

single wire or stranded wire 50 mm²
flexible wire without / with wire-end ferrules (according to DIN 46228) 35 mm²

Mounting

DIN rail mounting with screw and quick mounting in accordance with EN 60715

Faceplate for 45 mm standard cutout, F-handle grey, with interlock

Name	Art. No.	U _e	I _e DC-PV0	I _e DC-21B	Max. U _i PV	U _i *
KG80.T306/P1.VE2	70040669	630 V DC	60 A	60 A	750 V DC	1000 V

Data valid only if the pre-assembled bridges have not been modified.

* Valid for ungrounded or midpoint-grounded PV grids, overvoltage category III, pollution degree III

800 V DC : 60 A

1 x 2-pole

Switching program: 2-pole, 8 contacts per circuit (2 x 4 in series)

DC-side disconnectors for photovoltaic power supply systems in accordance with IEC 60364-712:2002

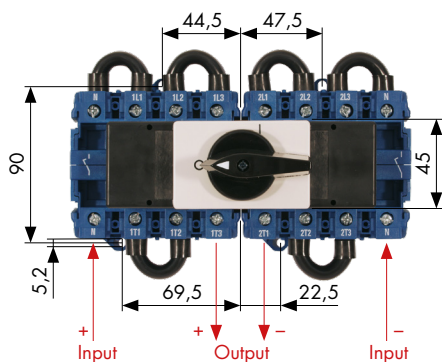
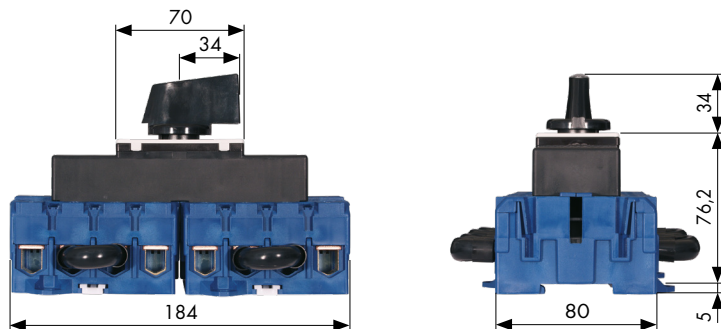

Wiring diagram	Twist torque for clamping screws	Stripped length
	KG80 3,00 Nm	KG80 14

General Data

Switch disconnectors in accordance with EN 60947-3, VDE 0660 part 107

Utilization category for photovoltaic applications: DC-PV0 Opening and closing a PV circuit to disconnect when no current is flowing

DC-21B Switching of resistive loads, including moderate overloads

Ambient temperature (open): 50 °C over 24 hours with peaks of up to 55 °C

Finger-safe terminals in accordance with VDE 0660-514 and BGV A3

Maximum conductor cross section (use only copper conductors)

single wire or stranded wire 50 mm²flexible wire without / with wire-end ferrules (according to DIN 46228) 35 mm²

Mounting

DIN rail mounting with screw and quick mounting in accordance with EN 60715

Faceplate for 45 mm standard cutout, F-handle black

Name	Art. No.	U _e	I _e DC-PV0	I _e DC-21B	Max. U _i PV	U _i *
 KG80.T308/PI.VE2	70040670	800 V DC	60 A	60 A	1000 V DC	1000 V

Data valid only if the pre-assembled bridges have not been modified.

* Valid for ungrounded or midpoint-grounded PV grids, overvoltage category III, pollution degree III

450 V DC : 18 A / 25 A / 32 A
500 V DC : 12 A / 18 A / 20 A

1 x 2-pole

Switching program: 2-pole, 4 contacts per circuit (2 x 2 in series)

DC-side disconnectors for photovoltaic power supply systems in accordance with IEC 60364-712:2002

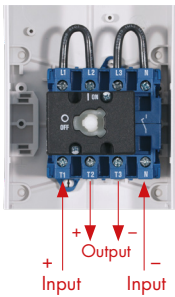
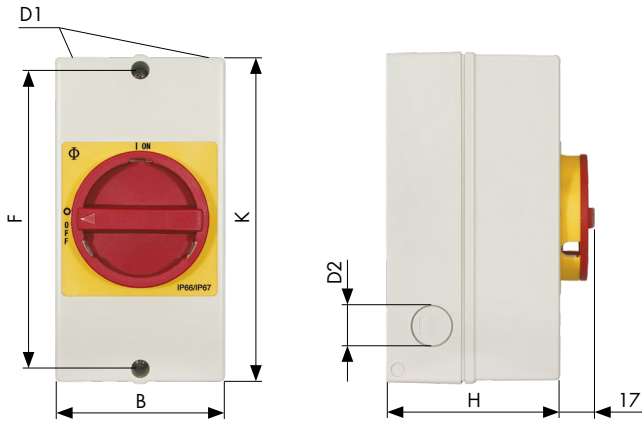

	KG20 KG32	KG41
B	85	100
D1	2 x Ø 25	2 x Ø 25
D2	Ø 20	Ø 25
F	150	178
H	82	93
K	160	190

Wiring diagram	Twist torque for clamping screws	Stripped length
	KG20/ KG32 1,25 Nm	KG20/ KG32 9
	KG41 1,80 Nm	KG41 10

General Data

Switch disconnectors in accordance with EN 60947-3, VDE 0660 part 107

Utilization category for photovoltaic applications: **DC-PV2** Connecting and disconnecting a PV circuit, where severe overcurrent may occur and where the current can flow in both directions

DC-21B Switching of resistive loads, including moderate overloads

Ambient temperature (enclosed): 50 °C over 24 hours with peaks of up to 55 °C

Finger-safe terminals in accordance with VDE 0660-514 and BGV A3, protection class IP 20

Maximum conductor cross section (use only copper conductors)

single wire or stranded wire KG20/KG32: 6 mm² KG41: 16 mm²
flexible wire without / with wire-end ferrules (according to DIN 46228) KG20/KG32: 4 mm² KG41: 10 mm²

Mounting

Plastic enclosure, protection class IP 66 / 67, fully insulated, knock-out entries

Handle red, in OFF-position lockable with padlocks, front plate background yellow, cover coupling with interlock

Name	Art. No.	Name	Art. No.	U _e	I _e DC-PV2		I _e DC-21B		Max. U _i PV	U _i *
					50°C ¹	60°C ²	50°C ¹	60°C ²		
KG20.T204/P3.KL51V	70040671	KG20.T104/P3.KL51V	70046567	450 V DC	18 A	18 A	25 A	25 A	540 V DC	690 V
KG32.T204/P3.KL51V	70040672	KG32.T104/P3.KL51V	70046568	450 V DC	25 A	23 A	25 A	23 A	540 V DC	690 V
KG41.T204/P3.KL11V	70040673	KG41.T104/P3.KL11V	70046569	450 V DC	32 A	32 A	40 A	40 A	540 V DC	690 V
KG20.T204/P3.KL51V	70040671	KG20.T104/P3.KL51V	70046567	500 V DC	12 A	12 A	21 A	21 A	600 V DC	690 V
KG32.T204/P3.KL51V	70040672	KG32.T104/P3.KL51V	70046568	500 V DC	18 A	18 A	21 A	21 A	600 V DC	690 V
KG41.T204/P3.KL11V	70040673	KG41.T104/P3.KL11V	70046569	500 V DC	20 A	20 A	28 A	28 A	600 V DC	690 V

¹ enclosed up to 50 °C over 24 hours with peaks of up to 55 °C | ² enclosed up to 60 °C over 24 hours with peaks of up to 65 °C

Data valid only if the pre-assembled bridges have not been modified.

* Valid for ungrounded or midpoint-grounded PV grids, overvoltage category III, pollution degree III

500 V DC : 25 A
650 V DC : 18 A / 25 A / 32 A
800 V DC : 12 A / 20 A

1 x 2-pole

Switching program: 2-pole, 6 contacts per circuit (2 x 3 in series)

DC-side disconnectors for photovoltaic power supply systems in accordance with IEC 60364-712:2002

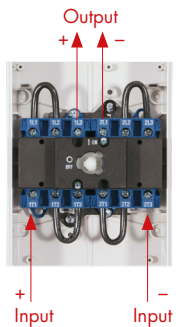
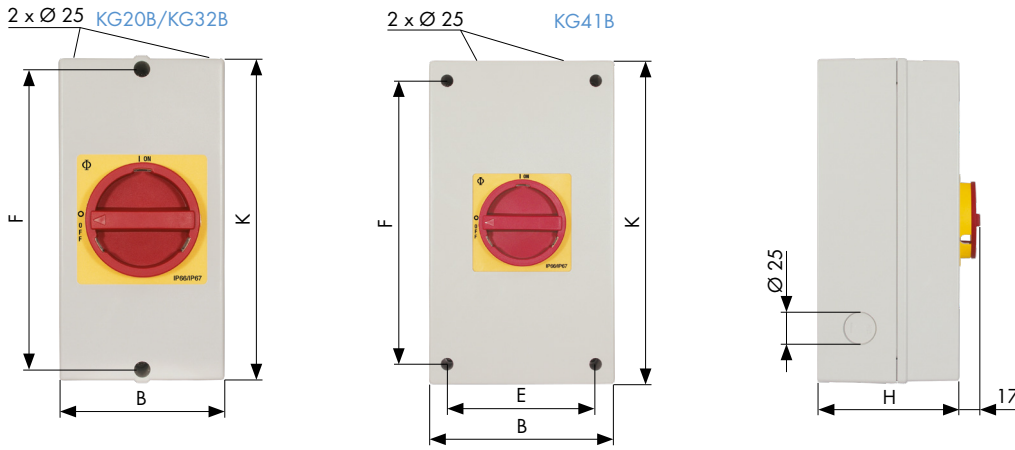

	KG20B KG32B	KG41B
B	100	145
E	—	124
F	178	229
H	93	107
K	190	250

Wiring diagram	Twist torque for clamping screws	Stripped length
	KG20B/ KG32B 1,25 Nm	KG20B/ KG32B 9
	KG41B 1,80 Nm	KG41B 10

General Data

Switch disconnectors in accordance with EN 60947-3, VDE 0660 part 107
 Utilization category for photovoltaic applications: **DC-PV2** Connecting and disconnecting a PV circuit, where severe overcurrent may occur and where the current can flow in both directions
DC-21B Switching of resistive loads, including moderate overloads
 Ambient temperature (enclosed): 50 °C over 24 hours with peaks of up to 55 °C (KG32B from 26 A: 35 °C over 24 hours with peaks of up to 40 °C)
 Finger-safe terminals in accordance with VDE 0660-514 and BGV A3, protection class IP 20
 Maximum conductor cross section (use only copper conductors)
 single wire or stranded wire KG20B/KG32B: 6 mm² KG41B: 16 mm²
 flexible wire without / with wire-end ferrules (according to DIN 46228) KG20B/KG32B: 4 mm² KG41B: 10 mm²

Mounting
 Plastic enclosure, protection class IP 66 / 67, fully insulated, knock-out entries
 Handle red, in OFF-position lockable with padlocks, front plate background yellow, cover coupling with interlock

Name	Art. No.	Name	Art. No.	U _e	I _e DC-PV2		I _e DC-21B		Max. U _i PV	U _i *
					50°C ¹	60°C ²	50°C ¹	60°C ²		
KG20B.T206/P3.KL11V	70040674	KG20B.T106/P3.KL11V	70046570	650 V DC	18 A	18 A	25 A	22 A	780 V DC	1000 V
KG32B.T206/P3.KL11V	70040675	KG32B.T106/P3.KL11V	70046572	500 V DC	25 A	22 A	25 A	22 A	600 V DC	1000 V
KG41B.T206/P3.KL11V	70040676	KG41B.T106/P3.KL11V	70046573	650 V DC	32 A	32 A	40 A	40 A	780 V DC	1000 V
KG20B.T206/P3.KL11V	70040674	KG20B.T106/P3.KL11V	70046570	800 V DC	12 A	12 A	21 A	21 A	1000 V DC	1000 V
KG32B.T206/P3.KL11V	70040675	KG32B.T106/P3.KL11V	70046572	650 V DC	25 A	22 A	25 A	22 A	780 V DC	1000 V
KG41B.T206/P3.KL11V	70040676	KG41B.T106/P3.KL11V	70046573	800 V DC	20 A	20 A	28 A	28 A	1000 V DC	1000 V

¹ enclosed up to 50 °C over 24 hours with peaks of up to 55 °C | ² enclosed up to 60 °C over 24 hours with peaks of up to 65 °C
 Data valid only if the pre-assembled bridges have not been modified.
 * Valid for ungrounded or midpoint-grounded PV grids, overvoltage category III, pollution degree III

600 V DC : 60 A
800 V DC : 60 A

1 x 2-pole

Switching program: 2-pole, 6 contacts per circuit (2 x 3 in series), 8 contacts per circuit (2 x 4 in series)

DC-side disconnectors for photovoltaic power supply systems in accordance with IEC 60364-712:2002

Switching program: 2-pole
6 contacts per circuit (2 x 3 in series)

650 V DC

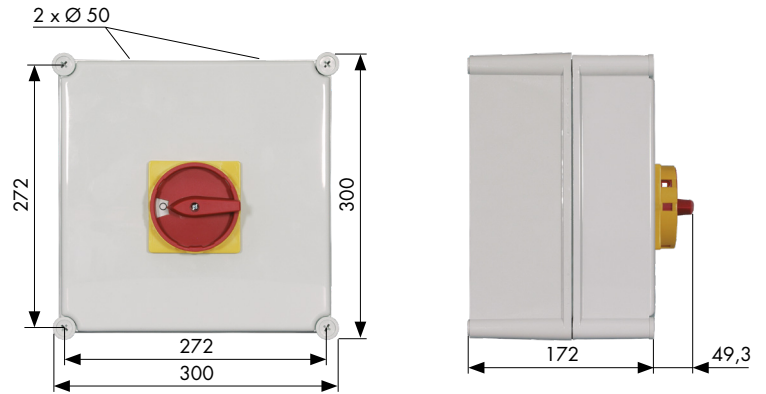
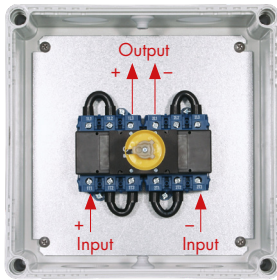

Switching program: 2-pole
8 contacts per circuit (2 x 4 in series)

800 V DC

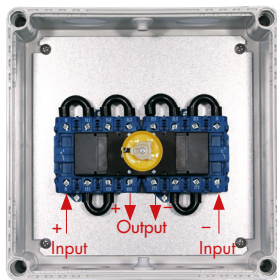

Wiring diagram 650 V DC	Wiring diagram 800 V DC	Twist torque for clamping screws	Stripped length
		KG80C 3,00 Nm	

General Data

Switch disconnectors in accordance with EN 60947-3, VDE 0660 part 107
 Utilization category for photovoltaic applications: DC-PV0 Opening and closing a PV circuit to disconnect when no current is flowing
 DC-21B Switching of resistive loads, including moderate overloads

Ambient temperature (enclosed): 50 °C over 24 hours with peaks of up to 55 °C

Finger-safe terminals in accordance with VDE 0660-514 and BGV A3

Maximum conductor cross section (use only copper conductors)
 single wire or stranded wire 50 mm²
 flexible wire without / with wire-end ferrules (according to DIN 46228) 35 mm²

Mounting

Plastic enclosure, protection class IP 66 / 67, fully insulated, knock-out entries
 Handle red, in OFF-position lockable with padlocks, front plate background yellow, cover coupling with interlock

Name	Art. No.	Name	Art. No.	U _e	I _e DC-PV0		I _e DC-21B		Max. U _i PV	U _i *
					50°C ¹	60°C ²	50°C ¹	60°C ²		
KG80C.T206/P3.STM	70040683	KG80C.T106/P3.STM	70046577	650 V DC	60 A	60 A	60 A	60 A	750 V DC	1000 V
KG80C.T208/P3.STM	70040684	KG80C.T108/P3.STM	70046578	800 V DC	60 A	55 A	60 A	55 A	1000 V DC	1000 V

¹ enclosed up to 50 °C over 24 hours with peaks of up to 55 °C | ² enclosed up to 60 °C over 24 hours with peaks of up to 65 °C

Data valid only if the pre-assembled bridges have not been modified.
 * Valid for ungrounded or midpoint-grounded PV grids, overvoltage category III, pollution degree III

500 V DC : 20 A

1 x 2-pole, 2 x 2-pole, 3 x 2-pole

Switching program: 1 x 2-pole, 2 x 2-pole and 3 x 2-pole

DC-side disconnectors for photovoltaic power supply systems in accordance with IEC 60364-712:2002

4-hole mounting

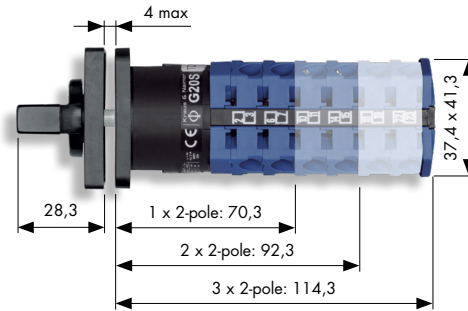

16 mm single-hole mounting

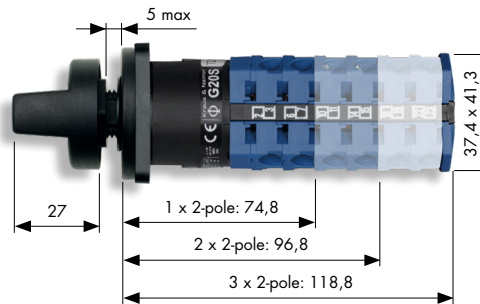
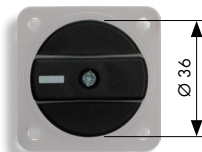

Wiring diagram

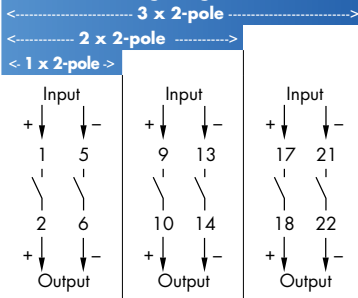

Hole pattern		Twist torque for clamping screws
4-hole	16 mm	
		G20S 0,6 Nm
		Stripped length
		G20S

General Data

Switch disconnectors in accordance with EN 60947-3, VDE 0660 part 107

Utilization category for photovoltaic applications: **DC-PV2** Connecting and disconnecting a PV circuit, where severe overcurrent may occur and where the current can flow in both directions

Ambient temperature (open): 55 °C over 24 hours with peaks of up to 65 °C over 8 hours

Finger-safe terminals in accordance with VDE 0660-514 and BGV A3, protection class IP 20

Maximum conductor cross section (use only copper conductors)

single wire or stranded wire 2 x 2,5 mm²
flexible wire without / with wire-end ferrules (according to DIN 46228) 2 x 2,5 mm²

Mounting

Front mounting with 4-hole mounting, maximum panel thickness of 4 mm
Faceplate background, brushed aluminum, standard handle

Mounting 16 mm single-hole mounting

Protection class IP66, maximum panel thickness of 5 mm
B-handle

Name 4-hole mounting	Art. No.	Name 16 mm single-hole mounting	Art. No.	Pole	U _e	I _e DC-PV2	Max. U _L PV	U _i *
G20S.TD3102.E	70009899	G20S.TD3102.FT16	70046692	1 x 2-pole	500 V DC	20 A	630 V DC	630 V
G20S.TD3104.EF	70009900	G20S.TD3104.FT16	70046693	2 x 2-pole	500 V DC	20 A	630 V DC	630 V
G20S.TD3106.E	70009901	G20S.TD3106.FT16	70046694	3 x 2-pole	500 V DC	20 A	630 V DC	630 V

Data valid only if the pre-assembled bridges have not been modified.

* Valid for ungrounded or midpoint-grounded PV grids, overvoltage category III, pollution degree III

750 V DC : 20 A

1 x 2-pole, 2 x 2-pole, 3 x 2-pole

Switching program: 1 x 2-pole, 2 x 2-pole and 3 x 2-pole

DC-side disconnectors for photovoltaic power supply systems in accordance with IEC 60364-712:2002

4-hole mounting

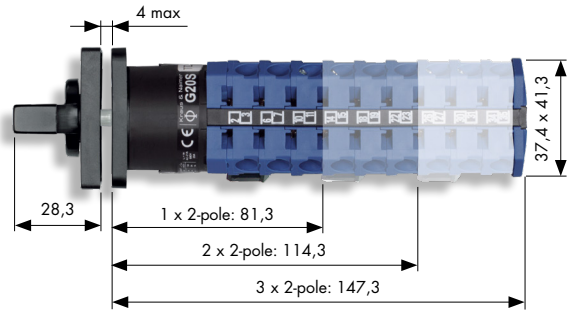
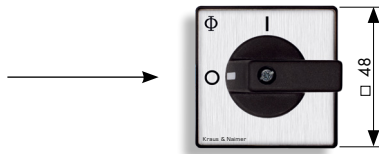

16 mm single-hole mounting

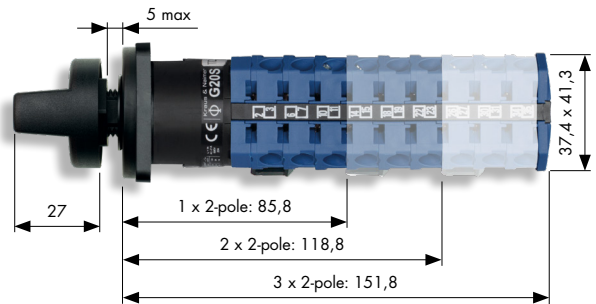

Wiring diagram

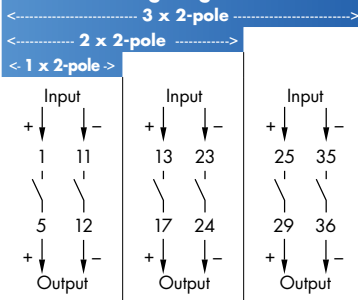

Hole pattern		Twist torque for clamping screws
4-hole	16 mm	
		G20S 0,6 Nm
		Stripped length
		G20S

General Data

Switch disconnectors in accordance with EN 60947-3, VDE 0660 part 107

Utilization category for photovoltaic applications: DC-PV2 Connecting and disconnecting a PV circuit, where severe overcurrent may occur and where the current can flow in both directions

Ambient temperature (open): 55 °C over 24 hours with peaks of up to 65 °C over 8 hours

Finger-safe terminals in accordance with VDE 0660-514 and BGV A3, protection class IP 20

Maximum conductor cross section (use only copper conductors)

single wire or stranded wire 2 x 2,5 mm²
flexible wire without / with wire-end ferrules (according to DIN 46228) 2 x 2,5 mm²

Mounting

Front mounting with 4-hole mounting, maximum panel thickness of 4 mm
Faceplate background, brushed aluminum, standard handle

Mounting 16 mm single-hole mounting

Protection class IP66, maximum panel thickness of 5 mm
B-handle

Name 4-hole mounting	Art. No.	Name 16 mm single-hole mounting	Art. No.	Pole	U _e	I _e DC-PV2	Max. U _L PV	U _i *
G20S.TD3351.E	70009912	G20S.D3351.FT16	70046695	1 x 2-pole	750 V DC	20 A	1000 V DC	1000 V
G20S.TD3352.E	70009913	G20S.TD3352.FT16	70046696	2 x 2-pole	750 V DC	20 A	1000 V DC	1000 V
G20S.TD3353.E	70009501	G20S.TD3353.FT16	70046697	3 x 2-pole	750 V DC	20 A	1000 V DC	1000 V

Data valid only if the pre-assembled bridges have not been modified.

* Valid for ungrounded or midpoint-grounded PV grids, overvoltage category III, pollution degree III

1000 V DC : 20 A

1 x 2-pole, 2 x 2-pole, 3 x 2-pole

Switching program: 1 x 2-pole, 2 x 2-pole and 3 x 2-pole

DC-side disconnectors for photovoltaic power supply systems in accordance with IEC 60364-712:2002

4-hole mounting

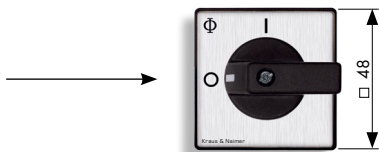

16 mm single-hole mounting

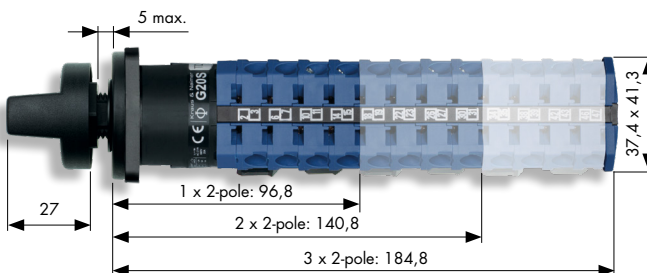
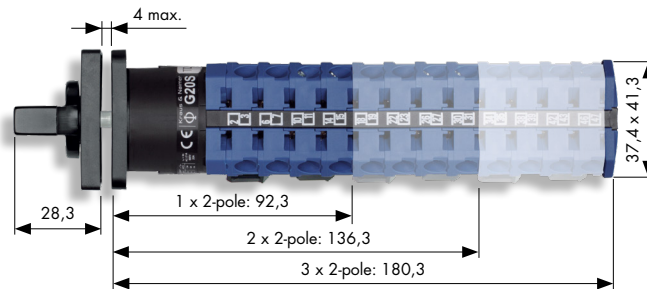
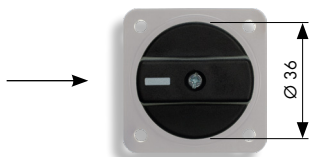

Wiring diagram

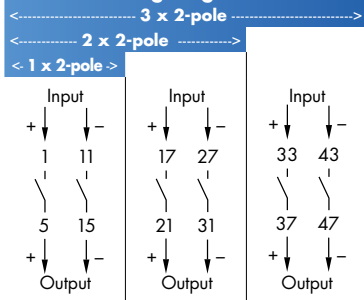

Hole pattern		Twist torque for clamping screws
4-hole	16 mm	
		G20S 0,6 Nm
		Stripped length
		G20S

General Data

Switch disconnectors in accordance with EN 60947-3, VDE 0660 part 107
 Utilization category for photovoltaic applications: DC-PV2 Connecting and disconnecting a PV circuit, where severe overcurrent may occur and where the current can flow in both directions

Ambient temperature (open): 55 °C over 24 hours with peaks of up to 65 °C over 8 hours
 Finger-safe terminals in accordance with VDE 0660-514 and BGV A3, protection class IP 20

Maximum conductor cross section (use only copper conductors)
 single wire or stranded wire 2 x 2,5 mm²
 flexible wire without / with wire-end ferrules (according to DIN 46228) 2 x 2,5 mm²

Mounting	Mounting 16 mm single-hole mounting
Front mounting with 4-hole mounting, maximum panel thickness of 4 mm	Protection class IP66, maximum panel thickness of 5 mm
Faceplate background, brushed aluminum, standard handle	B-handle

Name 4-hole mounting	Art. No.	Name 16 mm single-hole mounting	Art. No.	Pole	U _e	I _e DC-PV2	Max. U _L PV	U _i *
G20S.TD3202.E	70009394	G20S.TD3202.FT16	70017387	1 x 2-pole	1000 V DC	20 A	1000 V DC	1000 V
G20S.TD3204.E	70009914	G20S.TD3204.FT16	70017388	2 x 2-pole	1000 V DC	20 A	1000 V DC	1000 V
G20S.TD3206.E	70009502	G20S.TD3206.FT16	70017390	3 x 2-pole	1000 V DC	20 A	1000 V DC	1000 V

Data valid only if the pre-assembled bridges have not been modified.
 * Valid for ungrounded or midpoint-grounded PV grids, overvoltage category III, pollution degree III



 Kraus & Naimer

www.krausnaimer.com

© Kraus & Naimer, August 2022